

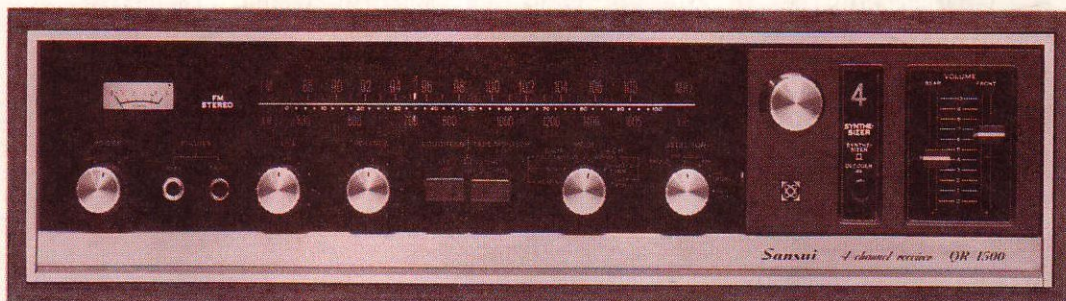

OPERATING INSTRUCTIONS & SERVICE MANUAL

4-CHANNEL RECEIVER

SANSUI QR-1500



Sansui

SANSUI ELECTRIC CO., LTD.

Congratulations on joining the thousands of proud, satisfied owners of quality stereo components from Sansui.

The Sansui QR-1500 4-channel receiver incorporates Sansui's unique QS Synthesizing/Decoding matrix (patents pending) that produces a multi-dimensional sound field so enthusiastically received by many audio experts as purely 'revolutionary'. An instrument that literally heralds the new age of 4-channel stereo sound reproduction, the QR-1500 not only converts ordinary 2-channel stereo discs, tapes and FM broadcasts into immensely richer 4-channel stereo sound, but, working in the capacity of a decoder, restores any 2-channel material encoded from four channels to its original full-fledged 4-channel status. It also incorporates the four all-silicon amplifiers which enable you to use a 4-channel tape machine to reproduce discrete 4-channel stereo.

To enjoy dynamic life-like 4-channel stereo sound at its best, you should be well acquainted not only with the operation of the various controls of the QR-1500, but with such matters as the proper positioning of speaker systems. Read carefully the instructions contained in this booklet, and you will be better prepared to take full advantage of the advanced performance capabilities of this new instrument for years to come.

CONTENTS

SWITCHES AND CONTROLS.....	3, 4
CONNECTIONS/OPERATIONS	5, 6
TAPE DECKS/PLACEMENT OF SPEAKERS	7, 8
SIMPLE MAINTENANCE HINTS	9, 10
SPECIFICATIONS.....	11
CHARACTERISTICS/ACCESSORIES	12
SCHEMATIC DIAGRAM	13, 14
DISASSEMBLY PROCEDURE	15
GENERAL TROUBLESHOOTING CHART	16
PRINTED CIRCUIT BOARDS AND PARTS LIST	
.....	17, 18, 19, 20, 21, 22, 23, 24
OTHER PARTS AND THEIR POSITIONS ON CHASSIS	
.....	25, 26

SWITCHES AND CONTROLS

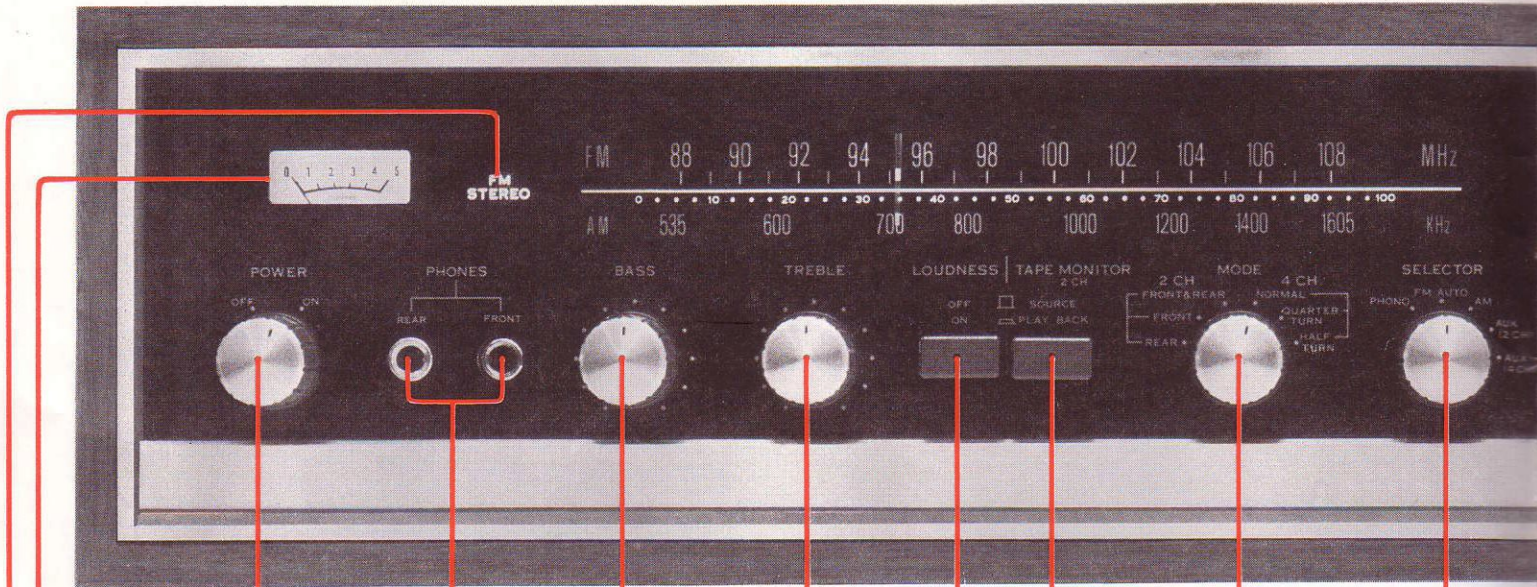

Power Switch

The receiver is turned on when the POWER switch is turned to the ON or right position.

Tuning Meter

This meter aids in pinpointing a station. The station is perfectly tuned when the needle swings as far to the right as possible.

FM Stereo Indicator

This indicator glows when the dial pointer crosses a station making an FM stereo broadcast. It remains lit during the stereo reception.

Headphones Jacks

Plug headphones into these jacks for monitoring or private listening. And all speakers connected to the QR-1500 will be automatically cut off. When the MODE switch is in the NORMAL position, you can hear the front sound from the right jack and the rear sound from the left jack.

Loudness Switch

When the LOUDNESS switch is depressed at low volumes, it provides the correct amount of bass and treble boost required to compensate for the tendency of the human ear to lose these frequencies at low listening levels.

Tape Monitor Switch

When this switch is once depressed, the receiver is set to play the sound from the playback head of the 2-channel tape deck connected to the 2-CH TAPE jacks on the rear panel of the receiver. Tape monitoring is possible only with a tape deck having separate record and playback heads. Except for such playback or monitoring, this switch must be in the SOURCE position.

Treble Control

The TREBLE control adjusts the intensity of the treble tones of the front speakers simultaneously.

Bass Control

The BASS control adjusts the intensity of the bass tones of the front speakers simultaneously.

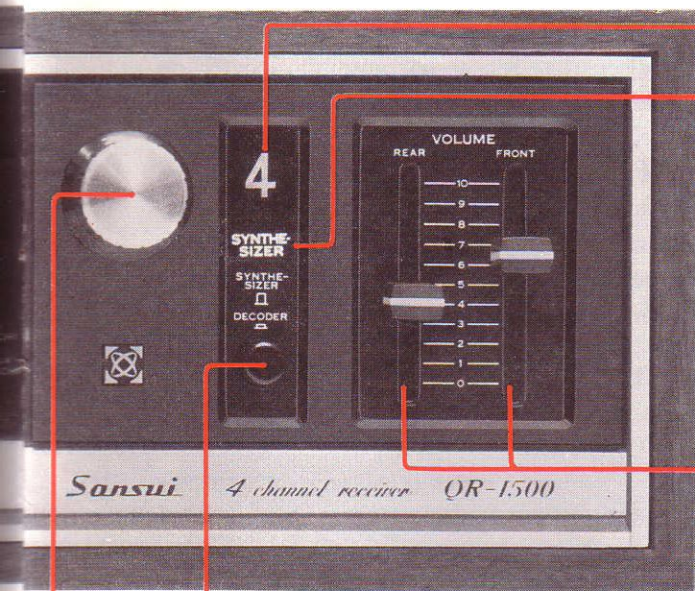

Digital Indicator

The numeral '2' or '4' appears depending on whether the MODE switch is set to the 2CH or 4CH position.

Synthesizer Indicator

The SYNTHESIZER indicator is illuminated when the MODE switch is set to the 4CH position and the SYNTHESIZER/DECODER switch is set to the SYNTHESIZER position (■). It is not lit while the SELECTOR switch is in the AUX (4CH) position.

Volume Controls

The FRONT VOLUME control adjusts the total volume of sound from the two front speakers, the REAR VOLUME control the two rear speakers. These controls are also used to adjust the balance of the front and rear speakers.

Synthesizer/Decoder Switch

■—Use this position to convert any ordinary 2-channel stereo source into 4-channels. To have the live listening experience in a concert hall, the 'Front 2-2 System' of speaker position is more effective (see page 7).

■—With the switch in this position, the original 4-channel material which has been encoded into two channels at the recording or broadcast end is recovered for 4-channel playback. The '2-2 system' of speaker position (see page 7) is more effective to re-create a hall-ambience around the listener. It also works well with ordinary two-channel materials of pop, rock, mood music, Moog sound, etc.

Selector Switch

PHONO—Selects a turntable connected to the PHONO inputs on the rear panel of the receiver.

FM AUTO—Selects FM programs.

AM—Selects AM programs.

AUX (2CH)—Selects the output of a component connected to the 2CH AUX jacks on the rear of the receiver.

AUX (4CH)—Selects the output of a component, such as a 4-channel tape deck, etc., connected to the 4CH AUX jacks on the rear of the receiver.

Tuning Knob

Mode Switch

2 CH—The 2CH position of the MODE switch connects the front sound to both or either of the front and/or rear speakers:

REAR—Connects the front sound to the rear speakers.

FRONT—Connects the front sound to the front speakers.

FRONT & REAR—Connects the front sound to both front and rear speakers.

4 CH—To enjoy the 4-channel stereo sound, set the MODE switch to:

NORMAL—For normal 4-channel stereo programs.

QUARTER TURN—This position is used to turn around sound by 90 degrees. The front left and right sound will be heard from the front and rear right speakers, and the rear left and right sound from the front and rear left speakers.

HALF TURN—To turn around sound by 180 degrees; so that the front sound will be heard from the rear speakers, and the rear sound from the front speakers.

CONNECTIONS/OPERATIONS

Connecting the Front and Rear Speakers

The speaker connections should be made in accordance with the diagram on the opposite page. To connect, depress the terminal button with one hand, push the stripped end of lead wire in the hole with the other hand, and release the button. Care should be taken not to mistake the front and rear channels, right and left channels, and plus and minus polarities. The required impedance of the speakers is 4 to 16 ohms.

If you want to connect two or more speakers to one channel in parallel, their combined impedance must be more than 4 ohms.

Connecting a Turntable

A turntable using a magnetic cartridge can be played through the QR-1500. Connect the left channel output of the turntable to the LEFT PHONO input of the receiver, and the right channel output of the turntable to the RIGHT PHONO input.

FM Antennas

Indoor Dipole Antenna

The 300-ohm folded dipole antenna (supplied) is for indoor use in urban or strong-signal areas. Connect the two leads from the dipole to the ANTENNA terminals marked FM 300 Ω on the rear panel, open the dipole antenna to a full 'T' and tack it up on a wall behind the component cabinet. It is necessary to position the antenna for the best signal pickup before the antenna is permanently tacked.

Outdoor Antenna

An outdoor antenna is recommended for optimum performance in all areas. Best results will be obtained with a rotator-driven antenna specifically designed for FM. Rotate the antenna until the best pickup is obtained. If the antenna is installed near a well-traveled street, it may pickup ignition noise. In this case, move it back from the street. Connect the 300-ohm lead-in to the ANTENNA terminals marked FM 300 Ω on the rear panel.

AM Antennas

The highly sensitive ferrite bar antenna, located on the rear panel of the QR-1500, is usually adequate for AM reception. Pull it toward you away from the back of the chassis. In weak-signal or fringe areas, a simple outdoor antenna may suffice. Connect one end of PVC wire (supplied) to the ANTENNA terminal marked AM and hook another end outdoors as illustrated on page 6.

Listening to Discs

1. Set the SELECTOR switch of the QR-1500 to the PHONO position.
2. Make appropriate settings of controls on the turntable connected to the QR-1500. Start playing the disc.
3. Adjust the VOLUME controls of the QR-1500 for the desired total volume of sound from the four speakers, and then for the desired balance of the front and rear speakers.
4. Use the BASS and TREBLE controls according to your preference or the room acoustics.

Listening to FM or AM Programs

1. Set the SELECTOR switch to FM AUTO or AM.
2. Turn the TUNING knob to reach the desired station. The station is perfectly tuned when the needle in the TUNING meter swings as far to the right as possible. The FM STEREO indicator glows when an FM stereo broadcast is received. It remains lit during the stereo reception.
3. Adjust the VOLUME controls for the desired total volume of sound from the speakers and for the desired balance of the front and rear speakers.
4. Use the BASS and TREBLE controls according to your preference or the room acoustics.

Note: If you want to hear ordinary 2-channel stereo through the QR-1500, set the MODE switch to the 2CH position and the SYNTHESIZER/DECODER switch to the SYNTHESIZER position. These procedures are also recommended for monophonic programs.

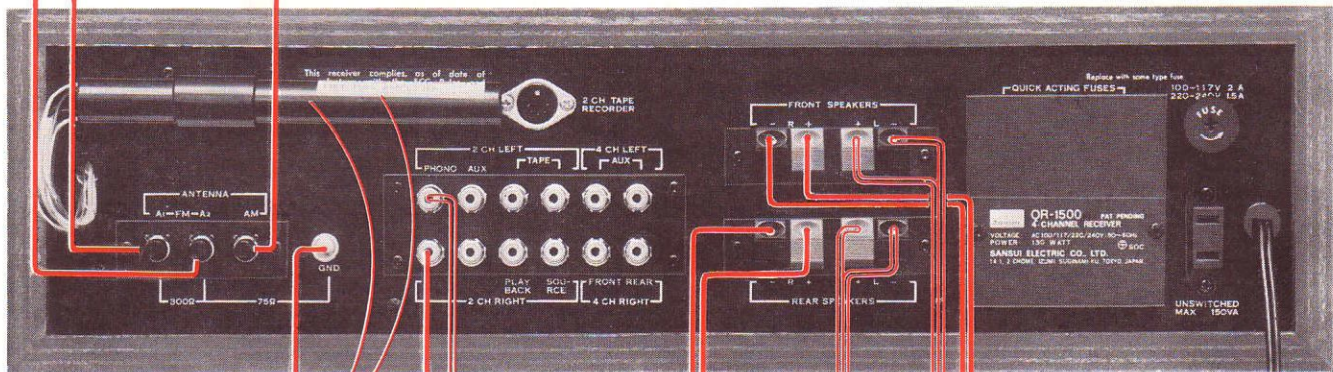
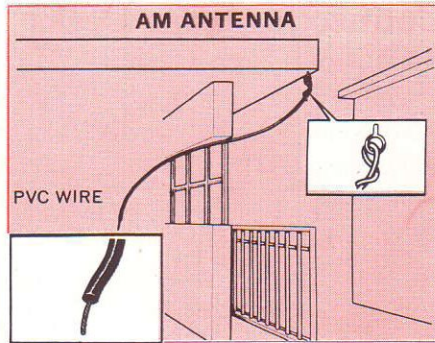
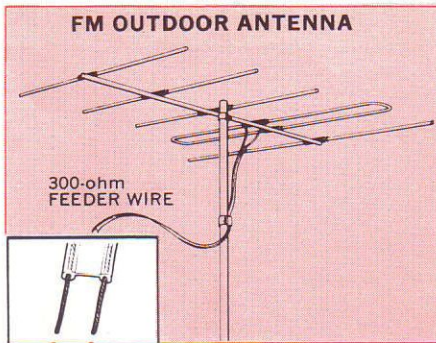
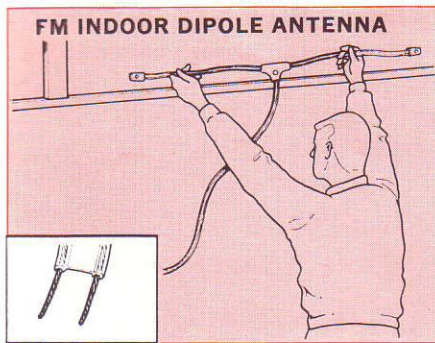

GROUNDING

TURNTABLE

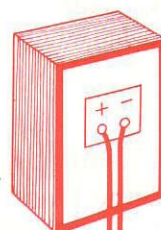
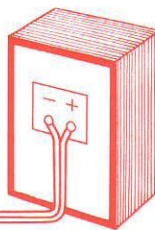
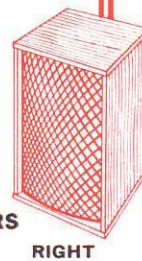

TAPE DECKS/PLACEMENT OF SPEAKERS

Connecting Tape Decks

2-Channel Tape Deck

There are two types of receptacles for connection of a 2-channel tape deck on the rear panel of the QR-1500: one is for pin plugs and the other for the DIN plug.

To connect your tape deck to the pin jacks:

1. Connect the left channel output of the tape deck to the left channel jack marked 2CH TAPE PLAYBACK, and the right channel output of the deck to the right channel jack marked 2CH TAPE PLAYBACK.

2. Connect the left channel input of the tape deck to the left channel jack marked 2CH TAPE SOURCE and the right channel input of the deck to the right channel jack marked 2CH TAPE SOURCE.

If you want to use the DIN connecting cord, just insert the DIN plug into the receptacle marked 2CH TAPE RECORDER on the rear panel of the QR-1500.

4-Channel Tape Deck

The QR-1500 is also provided with playback jacks for a 4-channel tape deck (not provided with recording jacks). Connect the outputs of the tape deck to the jacks marked 4CH AUX on the rear of the QR-1500. Be sure connect the right and left, front and rear channels correctly as shown on page 8. The 4CH AUX input jacks, of course, can accept other components than the 4-channel tape deck.

Operating Tape Decks

Recording with a 2-Channel Tape Deck

1. Set the SELECTOR switch to the program source (PHONO, FM AUTO, AUX (2CH) or AM) to be recorded.

2. Start the tape deck in the recording mode.

3. Make appropriate settings of controls on the tape deck. The recording is not affected by the controls of the QR-1500.

4. Set the TAPE MONITOR switch of the QR-1500 to PLAYBACK if you want to monitor the recording with the tape deck having separate heads for recording and playback.

Listening to Tapes with a 2-Channel Tape Deck

1. Depress the TAPE MONITOR switch to the

PLAYBACK position.

2. Start the tape deck in the playback mode.

3. Adjust the VOLUME controls of the QR-1500 for the desired volume of sound from the speakers and for the desired balance of the front and rear speakers.

4. Use the BASS and TREBLE controls of the QR-1500 according to your preference or the room acoustics.

Listening to Tapes with a 4-Channel Tape Deck

1. Turn the SELECTOR switch to AUX (4CH).

2. Start the tape deck in the playback mode.

3. Adjust the VOLUME controls of the desired volume of sound from the speakers and for the desired balance of the front and rear speakers.

4. Use the BASS and TREBLE controls of the QR-1500 according to your preference or the room acoustics.

Placement of Speakers

Basically there are two ways to place two pairs of speaker systems in the 4-channel stereo:

2-2 System (Fig. 1)

This is the speaker-in-each-corner placement that is being widely accepted as the standard speaker position for 4-channel stereo. This position permits the listener to enjoy music surrounded by the four speaker systems.

Front 2-2 System (Fig. 2)

This system is designed to create a live sound field in the listening area. The sound field is equivalent to the stage of a concert hall and the listener will have the live listening experience in the hall. With the SYNTHESIZER/DECODER switch in its SYNTHESIZER position, this system is more effective.

Compatible Placement (Fig. 3)

Place the rear speaker systems as shown in Fig. 3, p. 8, and the listener will be able to enjoy both systems in the limited space available. To enjoy the '2-2 system', he should situate himself near point A, and to enjoy the 'front-2-2 system', near point B.

CONNECTING TAPE DECKS

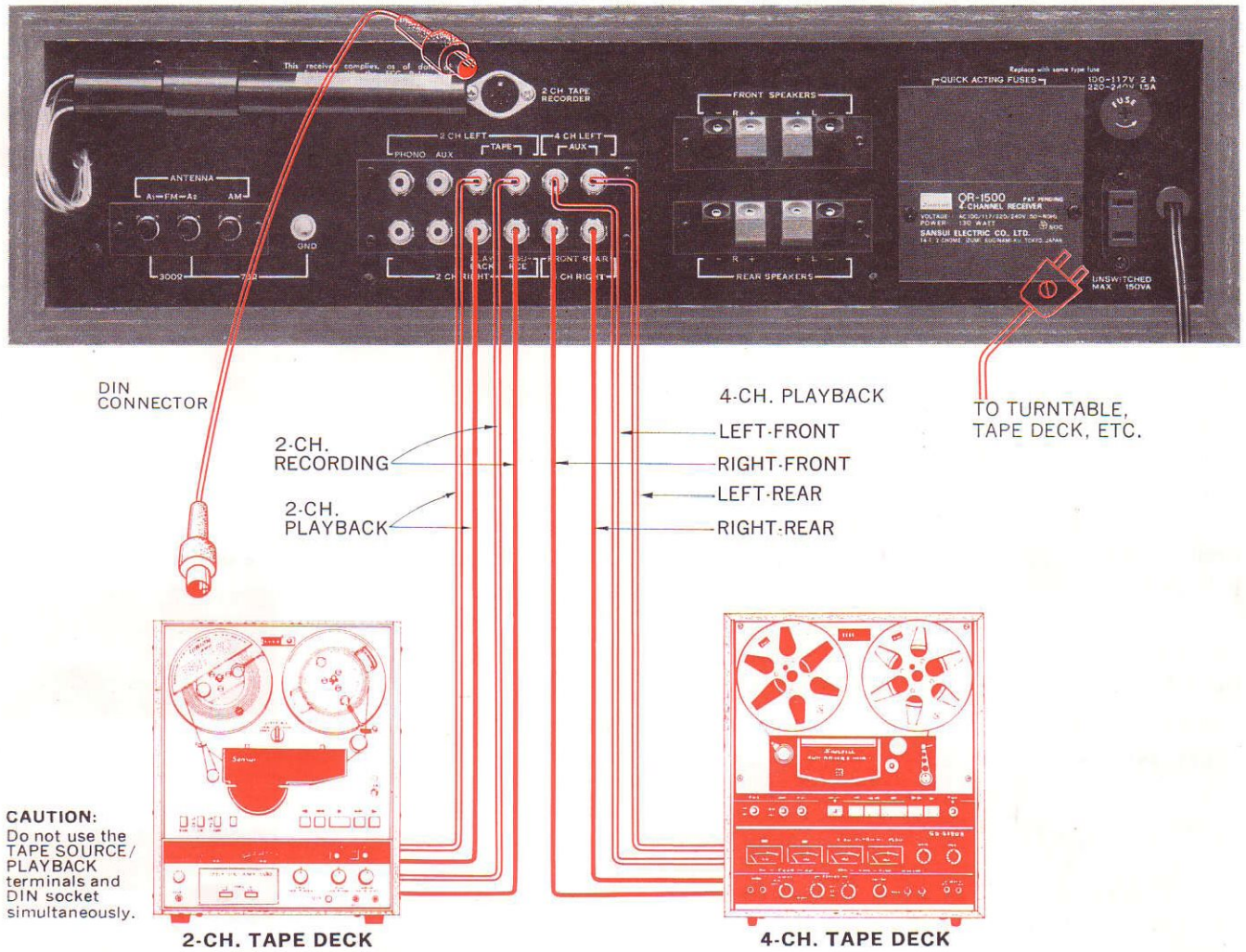

PLACEMENT OF SPEAKERS

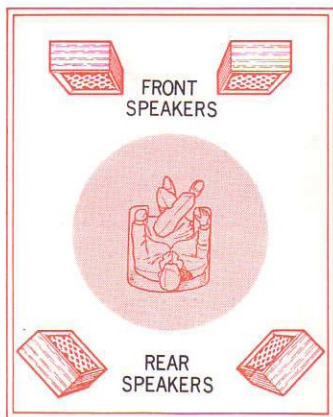

Fig. 1 2-2 SYSTEM

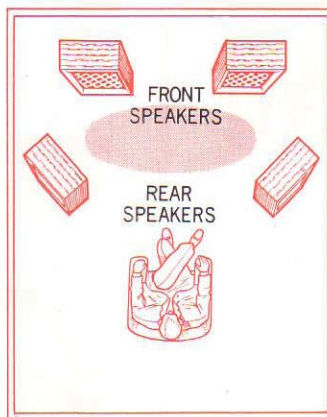

Fig. 2 FRONT 2-2 SYSTEM

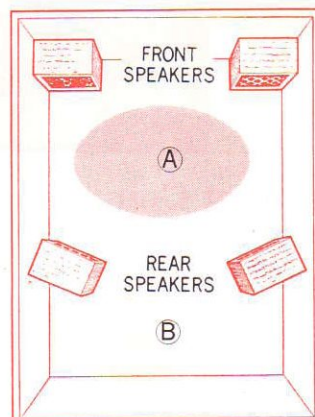

Fig. 3 COMPATIBLE PLACEMENT

SIMPLE MAINTENANCE HINTS

How to Eliminate Radio Noise

On AM Programs

AM reception noise can often be eliminated by slightly changing the position of the receiver. Some noises are peculiar to a certain broadcasting frequency or a certain time of day. Such noises result from the nature of AM signals. In fringe or weak-signal areas, connect the AM antenna (supplied) to the AM ANTENNA terminal as shown on page 6.

On FM Programs

Noise on FM programs may be attributed to either insufficient antenna input or interference from other electrical appliances. In fringe or weak-signal areas, install an outdoor multi-element antenna with a rotator and position it for best signal pickup. If it is installed near a well-traveled street, it may pickup ignition noise. In this case, move it back from the street. If still noisy, use coaxial cable (unbalanced 75-ohm) in place of the 300-ohm lead-in. Attach a matching transformer (300 Ω \rightarrow 75 Ω) to the antenna and then connect the center conductor to the FM-A₂ terminal, and the shield to the GND terminal on the rear panel of the QR-1500.

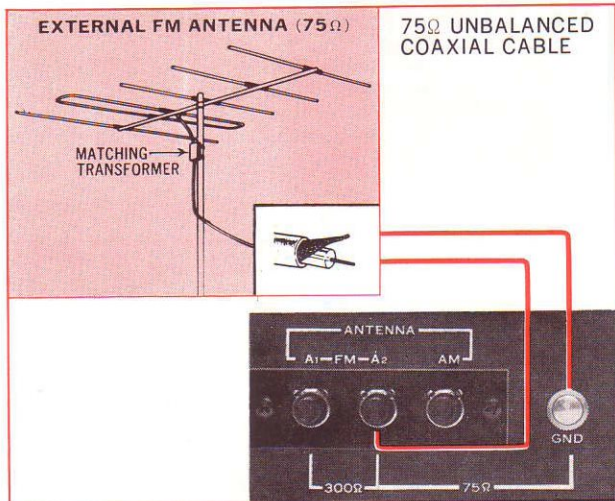

Connection of Components

Use the shielded cables to connect the audio components such as a tape deck, turntable, etc. to the QR-1500. These cables not only keep the distributed capacity to a minimum but are very stable against environmental changes. The use of ordinary lamp cord usually results in picking up hum. Generally, the longer the connecting cable, the more the

treble notes tend to be attenuated. It is therefore wise to keep their length below 7 feet or so. The shielded cable is made up for use as illustrated below:

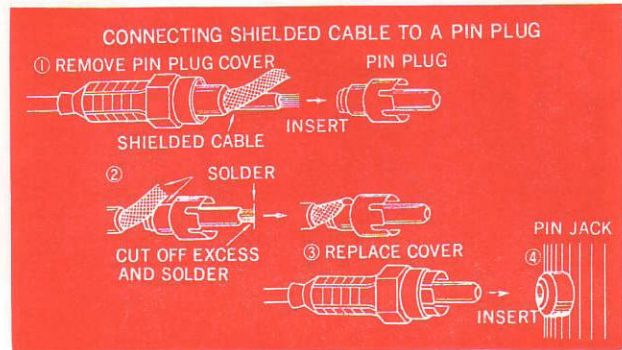

Grounding

Connect a PVC or enameled wire from the GND terminal to a grounded metal conductor such as a cold-water pipe, copper plate or carbon rod. Never connect it to a gas pipe. The grounding eliminates the possibility of hum and may reduce noise on radio programs.



AC Outlet

The AC outlet on the rear panel is live at all times and independent of the power switch. Its maximum rating is 150VA. It is dangerous to connect a component with a bigger power requirement. The voltage supplied by the AC outlet is the same as the power supply voltage used.

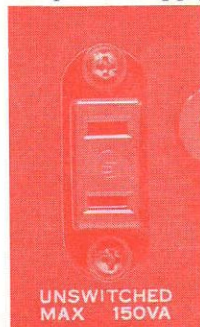

Power and Quick-Acting Fuses

If there is no sound from all speakers and the pilot light is off when the power switch is turned on, check the power fuse on the rear panel. Should the power fuse blow, remove the AC line cord and replace the blown fuse with a new glass-tubed fuse of the same capacity (2-ampere fuse required for 100-117 volt operation; 1.5-ampere unit for 220-240 volt operation). Please purchase the new fuse from your nearest electric goods store.

If the pilot light is on but there is no sound from both or either of the front and/or rear speaker systems, check the quick-acting fuses. If the right-front fuse, for example, should blow, the right-front speaker system becomes dead. To reach the fuses, remove the AC line cord from its outlet, remove two screws from the metal cover to which the name plate has been attached, and remove the metal cover. After eliminating the cause of the blowout, replace the blown fuse with a new 1.5-ampere fuse (supplied). The trouble may be attributed to the shorted output circuit or excessively large input.

If the new fuse blows when the power switch is turned on, contact your nearest Sansui dealer or Authorized Service Station.

Caution: Never use a piece of wire or a fuse of different capacity, even as a stop-gap measure, or serious danger could result.

POWER FUSES (100~117V 2A)
(220~240V 1.5A)

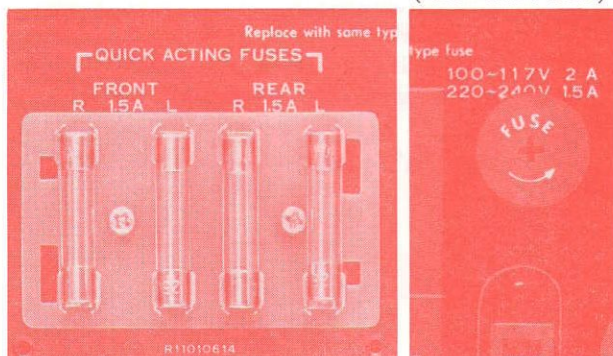

QUICK ACTING FUSES (1.5A × 4)

Phasing of Speakers

If the polarities (plus and minus) of the front left and right speaker systems are not identical, sound from them will lack a sense of natural sound, and also be weak in the bass range. The same applies to the polarities of the rear left and right speaker systems. Make sure the plus terminals of each speaker system have been connected to the corresponding red terminals of the QR-1500, and the minus terminals of each speaker system to the corresponding black terminals. If the sound is still unnatural, the rear speakers should be changed in position and direction until natural 4-channel stereo effect is obtained.

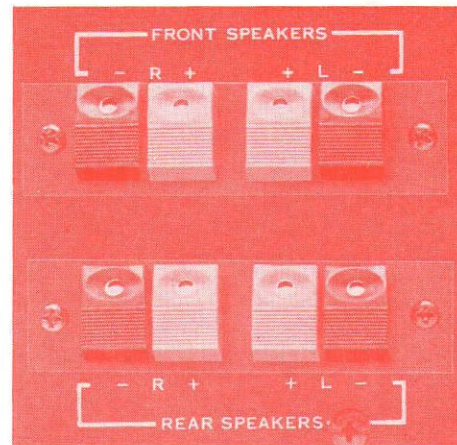

Voltage Adjustment

To reach the voltage selector, remove two screws from the metal cover to which the name plate has been attached, and remove the metal cover. The voltage selector makes it possible to operate the QR-1500 at the correct volt in any area. The volt has been pre-adjusted at our factory, but can be easily re-adjusted as follows:

1. Set the arrow on the voltage selector plug to the required volt: 100, 117, 220 or 240.
2. The power fuse should be changed, if required. For 100-117 volt operation, a 2-ampere fuse is required. For 220-240 volt operation, a 1.5-ampere fuse is required.

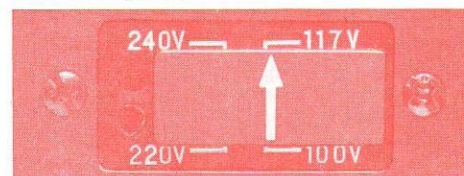

SPECIFICATIONS

AUDIO SECTION

POWER OUTPUT

MUSIC POWER (IHF): 100W (at 4 ohms load)
80W (at 8 ohms load)

CONTINUOUS POWER: 20W × 4 (at 4 ohms load)
15W × 4 (at 8 ohms load)

TOTAL HARMONIC DISTORTION:

less than 0.8% at rated output

INTERMODULATION DISTORTION (60Hz:7,000Hz
=4:1 SMPTE method): less than 0.8% at rated output

POWER BANDWIDTH (IHF):

20 to 30,000Hz at 8 ohms load

FREQUENCY RESPONSE (at normal listening level)

AUX 2-CHANNEL OVERALL: 30 to 30,000Hz ±2dB

CHANNEL SEPARATION: better than 50dB at 1,000Hz
rated output

HUM AND NOISE (IHF)

PHONO: less than -60dB

AUX 2-CHANNEL: less than -70dB

INPUT SENSITIVITY (at rated output, 1,000Hz)

PHONO (2-CH): 3mV (50k ohms)

AUX 2-CHANNEL: 180mV (50k ohms)

TAPE MON (pin) (2-CH):

180mV (50k ohms)

TAPE RECORDER (DIN) (2-CH):

180mV (50k ohms)

AUX 4-CHANNEL: 300mV (50k ohms)

RECORDING OUTPUT (2-CH)(at rated input, 1,000Hz)

TAPE REC (pin): 180mV

TAPE RECORDER (DIN): 30mV

LOAD IMPEDANCE: 4 to 16 ohms

DAMPING FACTOR: more than 20 at 8 ohms load

EQUALIZER

PHONO: RIAA NF Type

TONE CONTROLS (Front channel only)

BASS: +10dB -10dB at 50Hz

TREBLE: +8dB -10dB at 10,000Hz

LOUDNESS (Volume control at -30dB):

+8dB at 50Hz, +3dB at
10,000Hz

TUNER SECTION

<FM>

TUNING RANGE: 88 to 108MHz

SENSITIVITY

20dB QUIETING: 2.3μV

IHF: 3μV

TOTAL HARMONIC DISTORTION:

less than 1%

SIGNAL TO NOISE RATIO: better than 55dB

SELECTIVITY: better than 45dB

CAPTURE RATIO (IHF): 3dB

IMAGE FREQUENCY REJECTION:

better than 50dB

IF REJECTION: better than 90dB

SPURIOUS RESPONSE REJECTION:

better than 60dB

STEREO SEPARATION: better than 35dB at 400Hz

SPURIOUS RADIATION: less than 34dB

ANTENNA IMPEDANCE: 300 ohms balanced,
75 ohms unbalanced

<AM>

TUNING RANGE: 535 to 1,605kHz

SENSITIVITY: 200μV/m at 1,000kHz
(bar antenna)

IMAGE FREQUENCY REJECTION:

better than 50dB

IF REJECTION: better than 70dB at 1,000kHz

SELECTIVITY: better than 30dB

SYNTHESIZER SECTION

SYNTHESIZER/DECODER

GENERAL

SEMICONDUCTORS:

Transistors: 57 FET: 1 IC: 1 Diodes: 24

POWER REQUIREMENTS

POWER VOLTAGE: 100, 117, 220, 240V 50/60Hz

POWER CONSUMPTION: 72W (rated)

DIMENSIONS:

480mm (18¹⁵/₁₆") W 132mm (5¹/₄") H 310mm (12¹/₄") D

WEIGHT: 9.0kg (19.9 lbs)

CHARACTERISTICS / ACCESSORIES

POWER BANDWIDTH

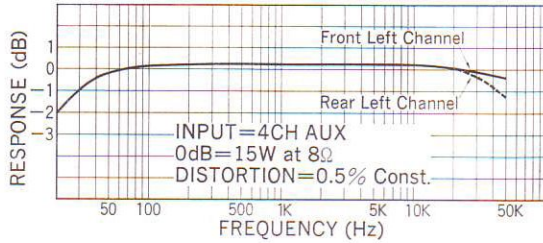

FM SELECTIVITY

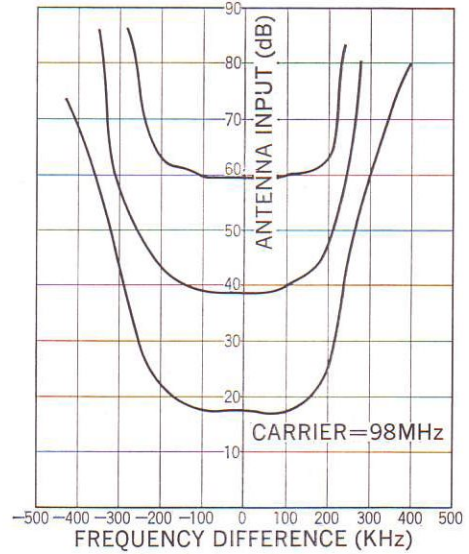

POWER OUTPUT HARMONIC DISTORTION

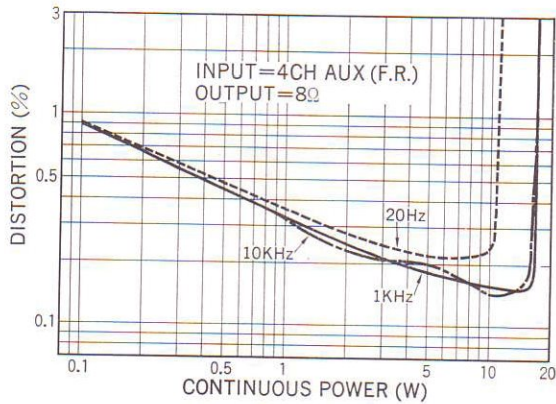

FM SENSITIVITY & IMAGE REJECTION

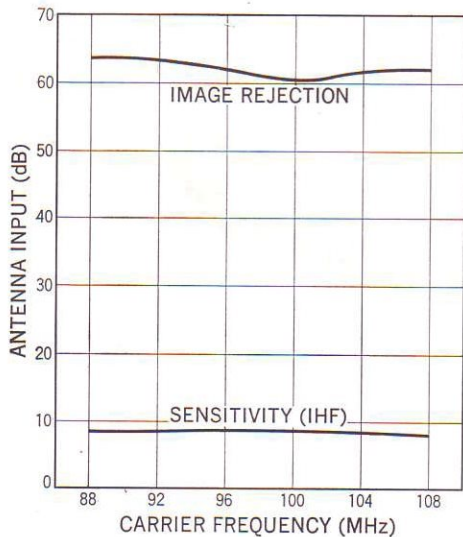

Accessories

1. OPERATING INSTRUCTIONS AND SERVICE MANUAL 1
2. OPERATING SHEET 1
3. FM ANTENNA 1
4. AM ANTENNA 1
5. PIN-PLUGS 2
6. POLISHING CLOTH..... 1
7. QUICK-ACTING FUSES (1.5A) 2
8. BUTTERFLY BOLTS 2
9. WASHERS..... 2

SCHEMATIC DIAGRAM

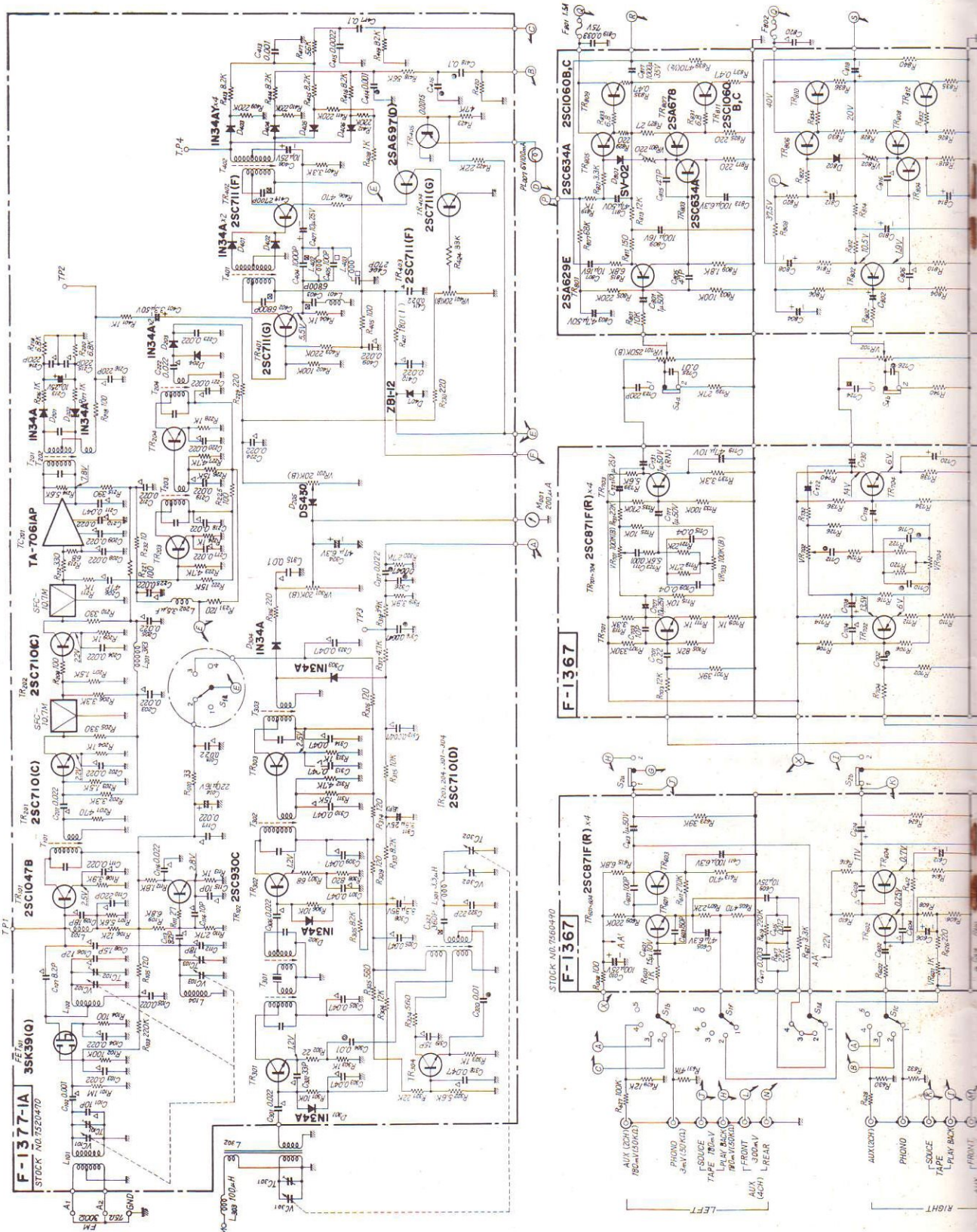

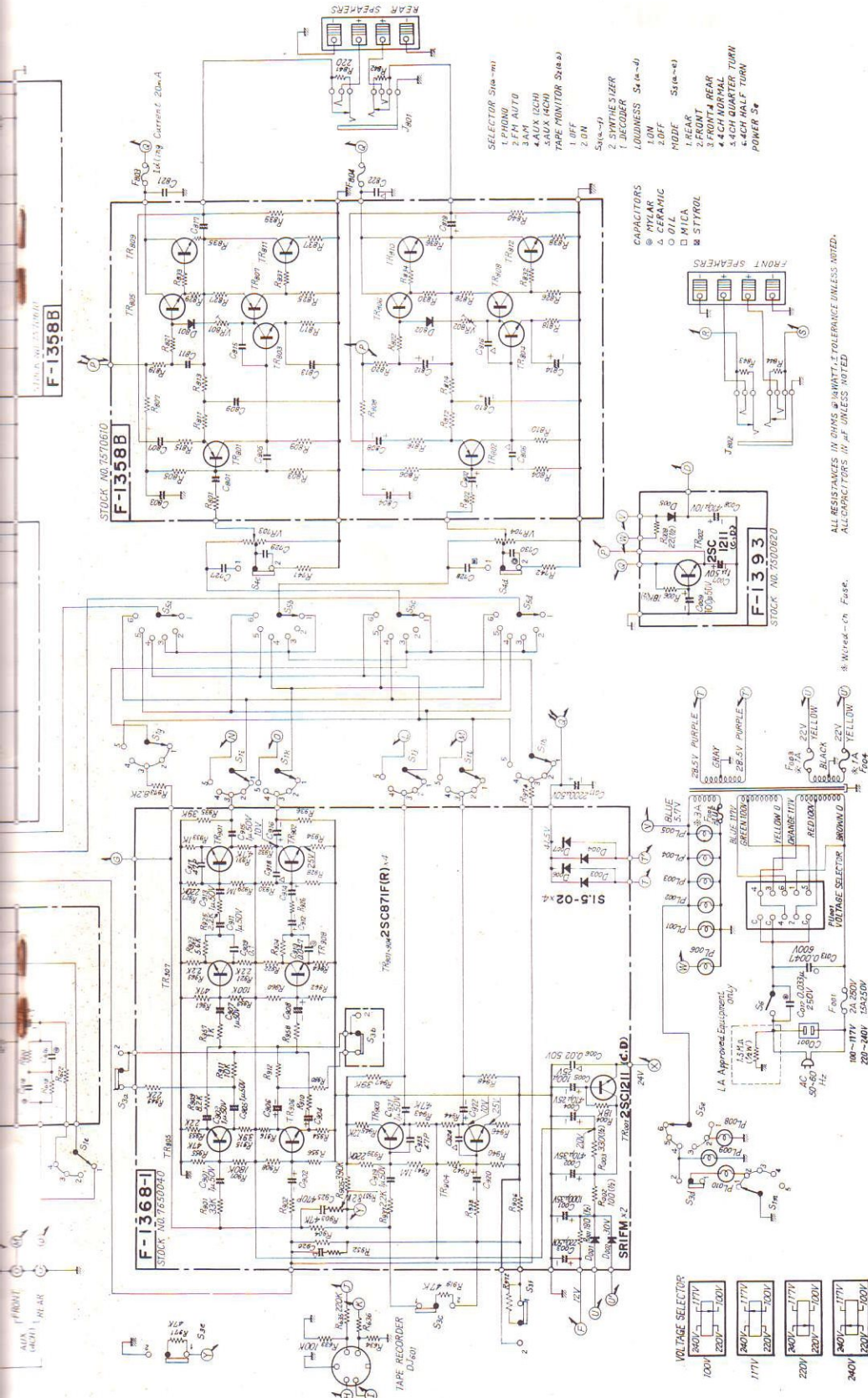

- SELECTOR (S1a-m)**
- 1. PHONO
 - 2. FM AUTO
 - 3. AM
 - 4. AUX 1 (CH)
 - 5. AUX 2 (CH)
 - 6. TAPE MONITOR (S1a,b)
 - 7. OFF
 - 8. ON
- S1a-m-j**
- 1. SYNTHESIZER
 - 2. DECODER
 - 3. LOUNNESS (S1a-m-j)
 - 4. ON
 - 5. OFF
 - 6. MODE
 - 7. REAR
 - 8. FRONT
 - 9. REAR
 - 10. 4.4CH NORMAL
 - 11. 4.4CH QUARTER TURN
 - 12. 4.4CH HALF TURN
 - 13. POWER S₁

- CAPACITORS**
- ⊙ MYLAR
 - △ CERAMIC
 - OIL
 - PICA
 - ⊛ STYROL

ALL RESISTANCES IN OHMS @ 194WATT, ±1% TOLERANCE UNLESS NOTED.
 ALL CAPACITORS IN μF UNLESS NOTED

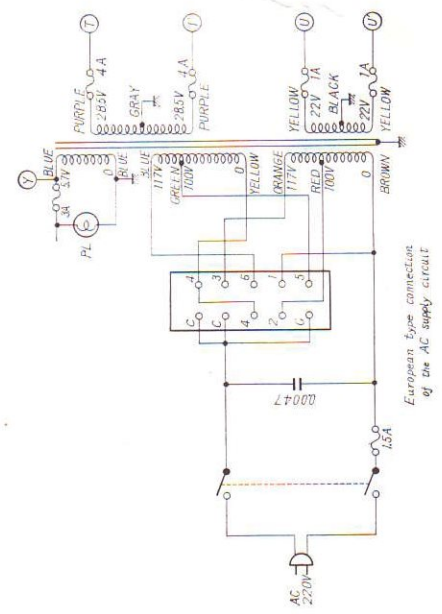
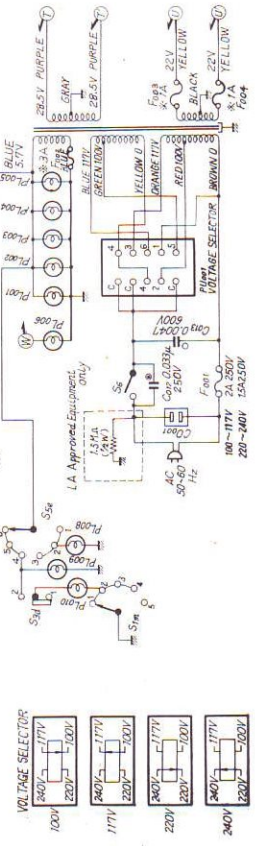

European type connection
 of the AC supply circuit

DISASSEMBLY PROCEDURE

REMOVING THE FRONT PANEL, WOOD CASE AND BOTTOM BOARD

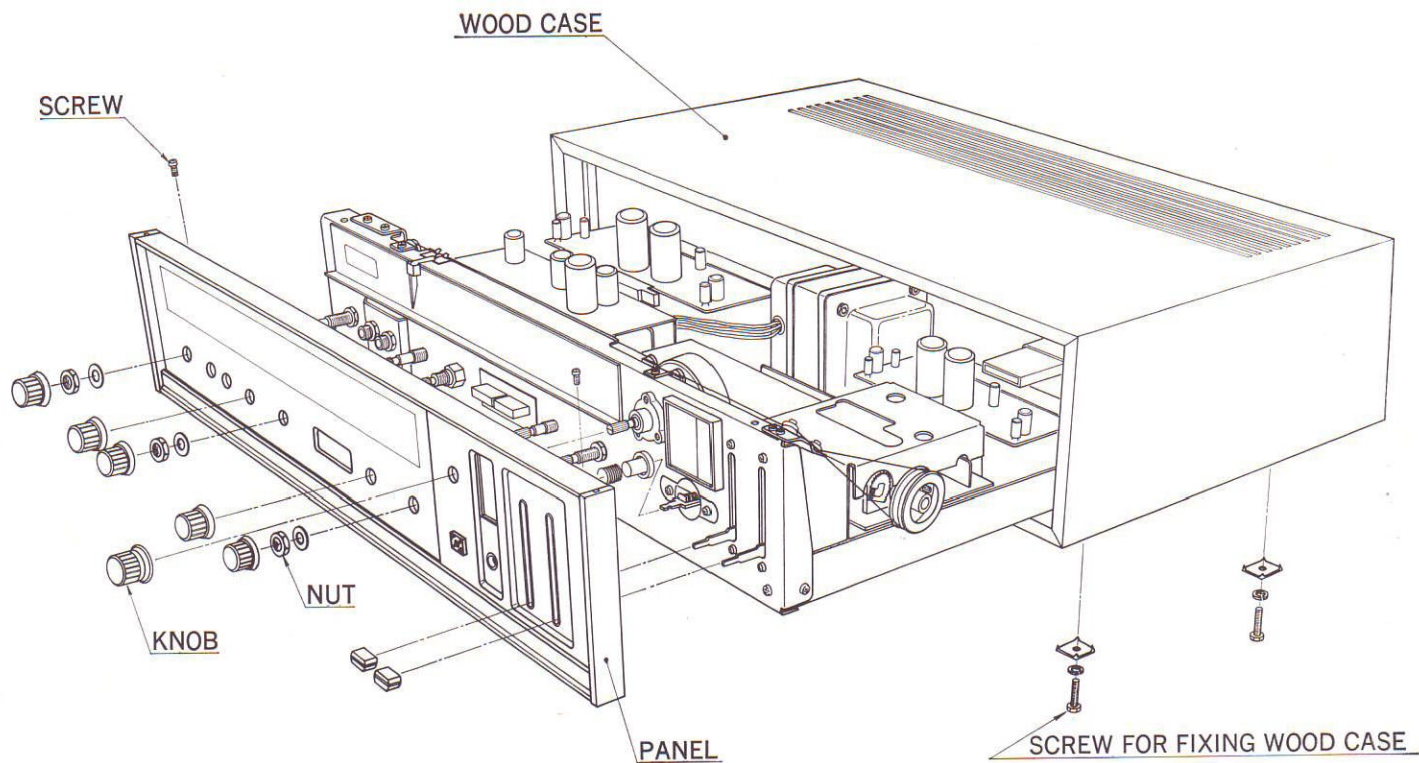

DIAL MECHANISM

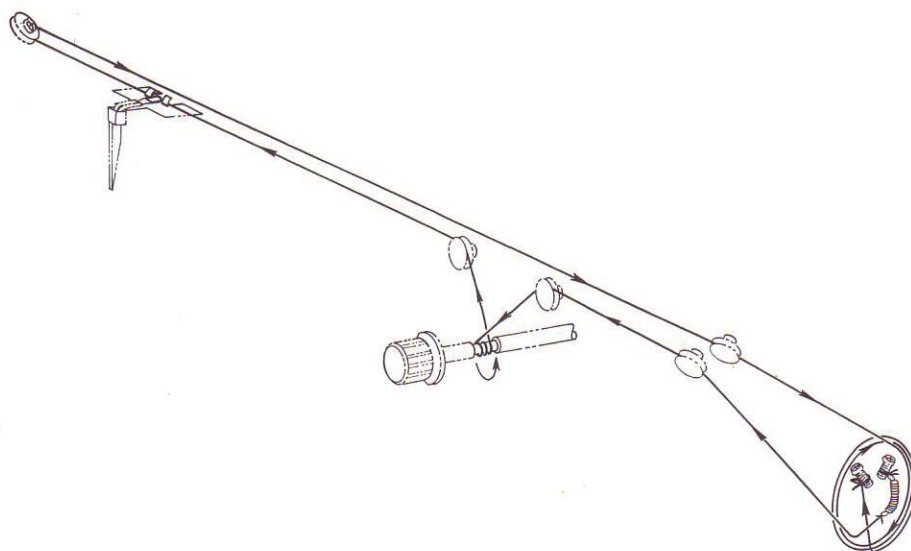

GENERAL TROUBLESHOOTING CHART

If the receiver is otherwise operating satisfactorily, the more common causes of trouble may generally be attributed to the following:

1. Incorrect connections or loose terminal contacts. Check the speakers, turntable, tape deck, antenna and power cord.
2. Improper operation. Before operating any audio com-

ponent, be sure to read its manufacturer's instructions.

3. Improper location of audio components. The proper positioning of components, such as speakers and turntable is essential to the maximum stereo enjoyment.

4. Defective audio components.

The following are more other common causes of malfunction and what to do about them.

PROGRAM	SYMPTOM	PROBABLE CAUSE	WHAT TO DO
AM, FM or MPX reception	A. Constant or intermittent noise heard at times or in certain areas	<ul style="list-style-type: none"> * Discharge or oscillation caused by electrical appliances, such as fluorescent lamp, D.C. motor, or rectifier * Insufficient antenna input due to ferroconcrete wall or long distance from station 	<ul style="list-style-type: none"> * Attach noise limiter to electrical appliance producing noise, or attach it to the receiver's power source * Reverse power cord plug/receptacle connections * Keep receiver at proper distance from other electrical appliances * Install antenna for maximum antenna efficiency. See "CONNECTIONS" in operating instructions
FM, or FM MPX reception	A. Noisy	<ul style="list-style-type: none"> * Poor noise limiter effect or too low SN ratio due to insufficient antenna input <p>Note: FM reception is affected considerably by transmission conditions of station, such as power and antenna efficiency. As a result, you may receive one station quite well while receiving another station poorly.</p>	<ul style="list-style-type: none"> * Install dipole antenna (supplied) for maximum signal strength * If this does not prove effective, use exclusive FM outdoor antenna * Excessively long antenna may cause noise
	B. A series of pops	<ul style="list-style-type: none"> * Ignition noise caused by starting of nearby automobile engine 	<ul style="list-style-type: none"> * Install antenna and its lead-in wire at proper distance from street or increase antenna input as described before
	C. Channel separation deteriorates during reception	<ul style="list-style-type: none"> * Excess heat 	<ul style="list-style-type: none"> * Circulation of room air is important to receiver. Be sure that receiver is well ventilated
Record playing or tape playback	A. Hum or howling	<ul style="list-style-type: none"> * Turntable placed directly on speaker * Wire other than shielded cable used * Loose terminal contact 	<ul style="list-style-type: none"> * Place cushion between turntable and speaker cabinet or place them away from each other * Connecting shielded cable should be as short as possible
	B. Surface noise	<ul style="list-style-type: none"> * Worn or old record * Worn phono stylus * Phono stylus is dusty * Improper stylus pressure 	<ul style="list-style-type: none"> * Recondition playback head of tape deck or stylus of turntable * Turn TREBLE control counterclockwise
4-Channel stereo playback	A. Position of musical instruments and voice not clear	<ul style="list-style-type: none"> * Incorrect phasing of speakers or input connections 	<ul style="list-style-type: none"> * Check phasing of speakers and input connections * The rear speakers should be changed in position and direction

PRINTED CIRCUIT BOARDS AND PARTS LIST

W: Parts No. X: Parts Name Y: Stock No. Z: Position of Parts

TUNER BLOCK <F-1377-1A> Stock No. 7520430

W	X	Y	Z
R101	1M Ω	0101105	1C
R102	100k Ω	0101104	1C
R103	220k Ω	0100224	1C
R104	100 Ω	0101101	1C
R105	120 Ω	0100121	1C
R106	12k Ω	0101123	1C
R107	5.6k Ω	0101562	1C
R108	3.9k Ω	0101392	1C
R109	6.8k Ω	0100682	1C
R110	2.7k Ω	0101272	1C
R111	27 Ω	0100270	1C
R112	1.8k Ω	0100182	1C
R113	1k Ω	0101102	1C
R201	470 Ω	0100471	1C
R202	3.3k Ω	0100332	1C
R203	1.5k Ω	0101152	1C
R204	1k Ω	0100102	1B
R205	330 Ω	0100331	1B
R206	3.3k Ω	0100332	1B
R207	1.5k Ω	0100152	1B
R208	100 Ω	0100101	1B
R209	1k Ω	0100102	1B
R210	330 Ω	0100331	1B
R211	1k Ω	0101102	1B
R212	330 Ω	0101331	1B
R213	68 Ω	0100680	1B
R214	5.6k Ω	0100562	1B
R215	390 Ω	0100391	1B
R216	1k Ω	0100102	1A
R217	1k Ω	0100102	1A
R218	100 Ω	0101101	1B
R219	6.8k Ω	0100682	1A
R220	6.8k Ω	0100682	1A
R221	100 Ω	0101101	1B
R222	15k Ω	0100153	2B
R223	4.7k Ω	0100472	2B
R224	1k Ω	0101102	2B
R225	100 Ω	0101101	2B
R226	15k Ω	0100153	2B
R227	4.7k Ω	0100472	2B
R228	1k Ω	0101102	2B
R229	220 Ω	0101221	2A
R230	220 Ω	0101221	2A
R231	120 Ω	0101121	2B
R232	10 Ω	0101100	1B
R301	10k Ω	0101103	2B
R302	22 Ω	0101220	2C
R303	1k Ω	0101102	2C
R304	12k Ω	0101123	2B
R305	82k Ω	0100823	2B
R306	10k Ω	0100103	2B
R307	68 Ω	0100680	1B
R308	820 Ω	0100821	1B
R309	120 Ω	0101121	2B
R310	8.2k Ω	0101822	2B

10% 1/4 W CR.

W	X	Y	Z	
R311	15k Ω	0100153	2B	
R312	4.7k Ω	0100472	1B	
R313	1k Ω	0100102	1B	
R314	120 Ω	0101121	2B	
R315	10k Ω	0101103	2B	
R316	220 Ω	0100221	2B	
R317	4.7k Ω	0100472	1A	
R318	39k Ω	0100393	1A	
R319	3.9k Ω	0100392	2A	
R320	27k Ω	0100273	1A	
R321	22k Ω	0100223	2C	
R322	5.6k Ω	0100562	2C	
R323	1k Ω	0100102	2C	
R324	560 Ω	0100561	2B	
R325	560 Ω	0101561	2B	
R326	120 Ω	0101121	2B	
R401	1k Ω	0101102	1A	
R402	100k Ω	0101104	1, 2 A	
R403	220k Ω	0101224	1, 2 A	
R404	1k Ω	0100102	1A	
R405	100 Ω	0101101	2A	
R406	470 Ω	0100471	2A	
R407	3.3k Ω	0100332	1A	
R408	1k Ω	0101102	2A	
R409	220k Ω	0100224	2A	
R410	220k Ω	0100224	1A	
R411	220k Ω	0100224	2A	
R412	220k Ω	0100224	2A	
R413	8.2k Ω	0100822	2A	
R414	8.2k Ω	0100822	1A	
R415	8.2k Ω	0100822	2A	
R416	8.2k Ω	0101822	1, 2 A	
R417	56k Ω	0100563	2A	
R418	56k Ω	0100563	1A	
R419	82k Ω	0100823	2A	
R420	82k Ω	0100823	1A	
R421	180 Ω	0104181	2A	
R422	22k Ω	0100223	2A	
R423	47k Ω	0101473	2A	
R424	33k Ω	0101333	2A	
VR201	} 20k Ω (B)	1032122	2A	
VR301		1032122	2A	
VR401		1032122	2A	
C101	10pF	} $\pm 10\%$ 50 V CC.	0664100	2C
C102	0.001 μ F		0654102	1C
C103	0.022 μ F		0656223	1C
C104	0.022 μ F	} $\begin{matrix} +80 \\ -20 \end{matrix}\%$ 25 V CC.	0656223	1C
C105	0.022 μ F		0656223	1C
C106	12pF	$\pm 10\%$ 50 V CC.	0661120	2C
C107	8.2pF	$\pm 0.5\mu$ F 50V CC.	0669005	1C
C108	1.5pF	$\pm 0.25\mu$ F 50 V CC.	0669021	1C
C109	18pF	} $\pm 10\%$ 50 V CC.	0661180	1C
C110	220pF		0660221	1C
C111	0.022 μ F	} $\begin{matrix} +80 \\ -20 \end{matrix}\%$ 25 V CC.	0656223	1C
C112	18pF		$\pm 5\%$ 50 V CC.	0669353

W	X		Y	Z
C113	8.2pF	0.25pF	50 V CC.	0669015 1C
C114	10pF	±10%	50 V CC.	0664100 1C
C115	10pF		0664100 1C	
C116	0.022μF		25 V CC.	0656223 1C
C117	0.022μF	+80% -20%	25 V CC.	0656223 1C
C201	0.022μF	+80% -20%	25 V CC.	0656223 1C
C202	0.022μF		0656223 1C	
C203	0.022μF		25 V CC.	0656223 1B
C204	0.022μF		0656223 1B	
C205	0.022μF		0656223 1B	
C206	47pF	±10%	50 V CC.	0660470 2B
C208	0.022μF	+80% -20%	25 V CC.	0656223 1B
C209	0.022μF		0656223 1B	
C210	0.022μF		25 V CC.	0656223 1B
C211	0.047μF		0656473 1B	
C212	0.022μF		0656223 1B	
C213	10μF	25 V EC.	0513100 1A	
C214	220pF	±10%	50 V CC.	0660221 1A
C215	220pF		0660221 1A	
C216	220pF		0660221 1A	
C217	0.022μF		0656223 2B	
C218	0.022μF		0656223 2B	
C219	0.022μF	+80% -20%	25 V CC.	0656223 2B
C220	0.022μF		0656223 2B	
C221	0.022μF		0656223 2B	
C222	0.022μF		0656223 2B	
C223	0.022μF		0656223 2B	
C224	0.022μF	0656223 2A		
C225	0.022μF	0656223 1A		
C302	33pF	±10%	50 V CC.	0660330 1C
C303	0.047μF	+80% -20%	25 V CC.	0656473 2C
C304	0.01μF	±10%	50 V MC.	0601107 2C
C305	0.047μF	+80% -20%	25 V CC.	0656473 2B
C306	0.022μF		0656223 1B	
C307	0.047μF		0656473 1B	
C308	3.3μF		25 V BPEC.	0533339 2B
C309	0.047μF		25 V CC.	0656473 2B
C310	0.047μF	+80% -20%	25 V CC.	0656473 1B
C311	3.3μF	25 V BPEC	0533339 2B	
C312	0.0047μF	±10%	50 V MC.	0601476 2A
C313	0.047μF	+80% -20%	25 V CC.	0656473 1B
C314	0.047μF	-20%	25 V CC.	0656473 2B
C315	0.01μF	+80% -20%	25 V CC.	0656103 2A
C316	0.0047μF	±10%	50 V MC.	0601476 1A
C317	0.022μF		0601227 2A	
C318	0.047μF	+80% -20%	25 V CC.	0656473 2C
C319	15pF	±10%	50 V CC.	0660150 2C
C320	0.01μF	±10%	50 V MC.	0601107 2B, C
C321	360pF	±5%	50 V SC.	0620361 2B
C322	22pF	±10%	50 V CC.	0660220 2B
C323	0.047μF	+80% -20%	25 V CC.	0656473 2A, B
C324	47μF	6.3 V EC.	0510470 2A	
C325	0.047μF	+80% -20%	25 V CC.	0656473 2B
C326	0.0047μF	±10%	50 V MC.	0601476 1A
C401	3.3μF	50 V EC.	0515339 1A	

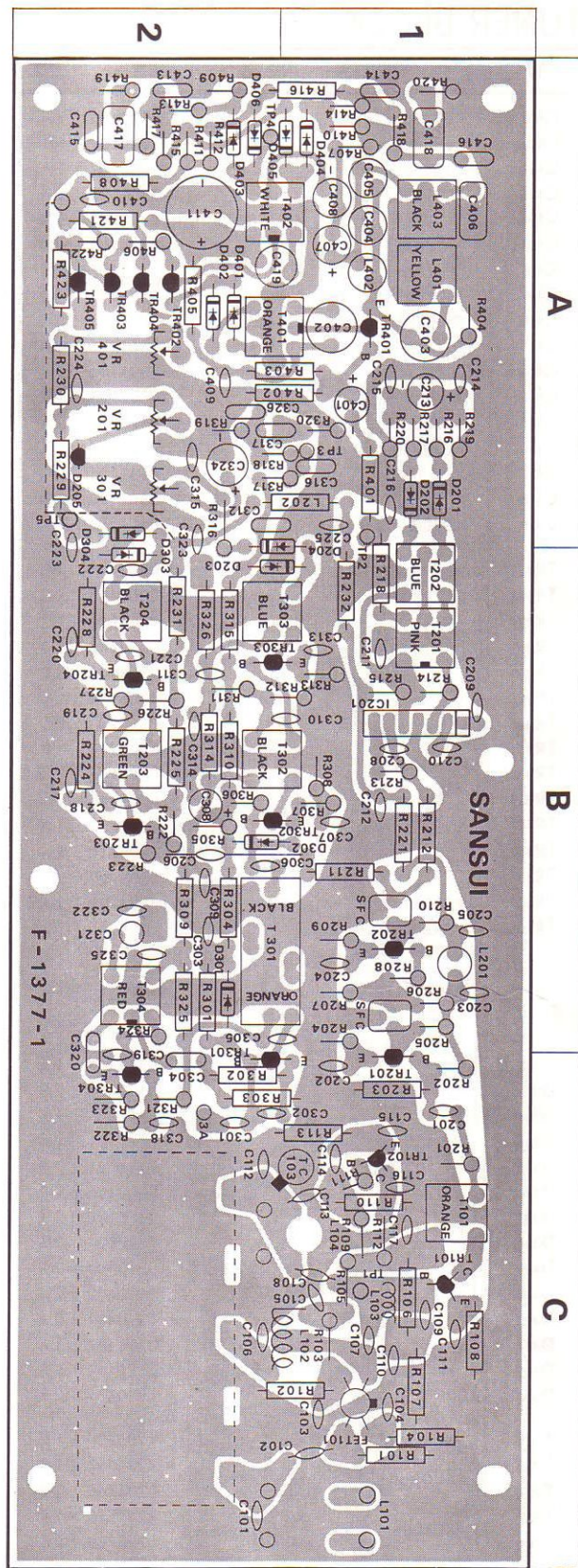

PRINTED CIRCUIT BOARDS AND PARTS LIST

W: Parts No. X: Parts Name Y: Stock No. Z: Position of Parts

TUNER BLOCK <F-1377-1A> Cont'd

W	X	Y	Z
C402	6800pF	0620682	1 A
C403	6800pF	0620682	1 A
C404	1000pF	0620102	1 A
C405	100pF	0620101	1 A
C406	270pF	0640271	1 A
C407	10μF	0513100	1 A
C408	10μF	0513100	1 A
C409	0.022μF	0656223	2 A
C410	0.022μF	0656223	2 A
C411	0.022μF	0656223	2 A
C413	0.001μF	0601106	2 A
C414	0.001μF	0601106	1 A
C415	2200pF	0620222	2 A
C416	2200pF	0620222	1 A
C417	0.1μF	0601108	2 A
C418	0.1μF	0601108	1 A
C419	2700pF	0620272	1, 2 A
TR101	2SC1047 (B)	0305800	1 C
TR102	2SC930 (C)	0305790	1 C
TR201	2SC710 (C)	0305942	1 C
TR202		0305942	1 B
TR203		0305943	2 B
TR204		0305943	2 B
TR301	2SC710 (D)	0305943	2 C
TR302		0305943	1 B
TR303		0305943	1, 2 B
TR304		0305943	2 C
TR401	2SC711 (G)	0305733	1 A
TR402	2SC711 (F)	0305732	2 A
TR403		0305732	2 A
TR404	2SC711 (G)	0305733	2 A
TR405	2SA697 (D) or 9000-1 (C)	0300311 or 0300200	2 A
FET101	3SK39 (Q)	0370080	1 C
D201	IN34A	0310400	1 A
D202		0310400	1 A
D203		0310400	2 B
D204		0310400	1 B
D205	DS-430	0340090	2 A
D301	IN34A	0310400	2 B
D302		0310400	1 B
D303		0310400	2 B
D304		0310400	2 B
D401		0310400	2 A
D402		0310400	2 A
D403		0310401	2 A
D404		0310401	1 A
D405	IN34A (Y)	0310401	2 A
D406		0310401	2 A
T101	FM IFT	4235790	1 C
T201	FM Discriminating Transformer	4235750	1 B
T202		4235760	1 B
T203		4235770	2 B
T204	FM Meter Coil	4235780	2 B

W	X	Y	Z
T301	CFU-73B Ceramic Filter	4230550	1, 2 B
T302	AM IFT	4230510	1, 2 B
T303		4230500	1, 2 B
T304		4220280	2 B
T401	AM OSC Coil	4240630	1, 2 A
T402		4240620	1, 2 A
L101	FM Antenna Coil	4220370	1 C
L102	FM RF Coil	4210090	1 C
L103	Choke Coil	4290110	1 C
L104	FM OSC Coil	4220270	1 A
L201	Peaking Coil	4900100	1 B
L202		4290011	1, 2 A
L301		4290011	
L401	MPX Coil	4240640	1 A
L402	Ferri Inductor	4900030	1 A
L403	MPX Coil	4240610	1 A
CF201	SFC-10.7MA Ceramic Filter	0910120	1 B
CF202		0910120	1 B
VC101	AM/FM Variable Capacitor	1220110	
VC102			
VC103			
VC301			
VC302			
TC102	Trimer Capacitor	1230090	1 C
IC201	TA-7061AP	0360060	1 B

Abbreviations

- CR** : Carbon Resistor
- SR** : Solid Resistor
- CeR** : Cement Resistor
- CC** : Ceramic Capacitor
- MC** : Mylar Capacitor
- EC** : Electrolytic Capacitor
- SC** : Styrol Capacitor
- MIC** : Mica Capacitor
- TC** : Tantalum Capacitor
- OC** : Oil Capacitor
- BpEC**: Bi-Polar Electrolytic Capacitor

POWER AMP. BLOCK<F-1358B> Stock No. 7570610

W	X	Y	Z
R801	10kΩ	0101103	2C
R802	10kΩ	0101103	2A
R803	100kΩ	0101104	2C
R804	100kΩ	0101104	2A
R805	220kΩ	0101224	2C
R806	220kΩ	0101224	2A
R807	68kΩ	0101683	2C
R808	68kΩ	0101683	2A
R809	1.8kΩ	0101182	2C
R810	1.8kΩ	0101182	2A
R811	150Ω	0101151	2C
R812	150Ω	0101151	2A
R813	12kΩ	0101123	2C
R814	12kΩ	0101123	2A
R815	6.8kΩ	0101682	2C
R816	6.8kΩ	0101682	2A
R817	220Ω	0101221	1C
R818	220Ω	0101221	2A
R819	1kΩ	0101102	2C
R820	1kΩ	0101102	2A
R821	3.3kΩ	0101332	2C
R822	3.3kΩ	0101332	2A, B
R825	220Ω	0101221	1C
R826	220Ω	0101221	1A
R827	27Ω	0101270	1C
R828	27Ω	0101270	1A
R829	220Ω	0101221	2B, C
R830	220Ω	0101221	2A, B
R831	6.8Ω	0101689	1C
R832	6.8Ω	0101689	1A
R833	6.8Ω	0101689	1B, C
R834	6.8Ω	0101689	1A, B
R835	0.47Ω	0152478	1B, C
R836	0.47Ω	0152478	1A, B
R837	0.47Ω	0152478	1, 2C
R838	0.47Ω	0152478	1, 2A
R839	470Ω	0111471	2B
R840	470Ω	0111471	2B
VR801	200Ω (B)	1032020,1,2	1B
VR802		1032020,1,2	1B
C801	1μF	0515109	1C
C802	1μF	0515109	2A
C803	4.7μF	0515479	2C
C804	4.7μF	0515479	2A
C805	47pF	0660470	2B
C806	47pF	0660470	2A
C807	10μF	0512100	2B, C
C808	10μF	0512100	2A, B
C809	100μF	0512101	2C
C810	100μF	0512101	2A
C811	47μF	0515470	1C
C812	47μF	0515470	1A
C813	100μF	0510101	2C
C814	100μF	0510101	2A
C815	47pF	0660470	1C
C816	47pF	0660470	1A

±10% 1/4W CR.

±10% 2W CeR.

±10% 1/2W SR.

W	X	Y	Z	
C817	1000μF	35 V EC.	0544104	2B
C818	1000μF		0544104	2B
TR801	2SA629 (E, F)	0300330, 1	2C	
TR802		0300330, 1	2A	
TR803		0305891, 2	2C	
TR804	2SC634A (6, 7)	0305891, 2	1, 2A	
TR805		0305891, 2	1, 2B	
TR806		0305891, 2	1B	
TR807	2SA678 (6, 7)	0300291, 2	1C	
TR808		0300291, 2	1A	
TR809		0305711, 2	1B, C	
TR810	2SC1060 (B, C)	0305711, 2	1A, B	
TR811		0305711, 2	1C	
TR812		0305711, 2	1A	
D801	SV-02	0310490	1C	
D802		0310490	1A	

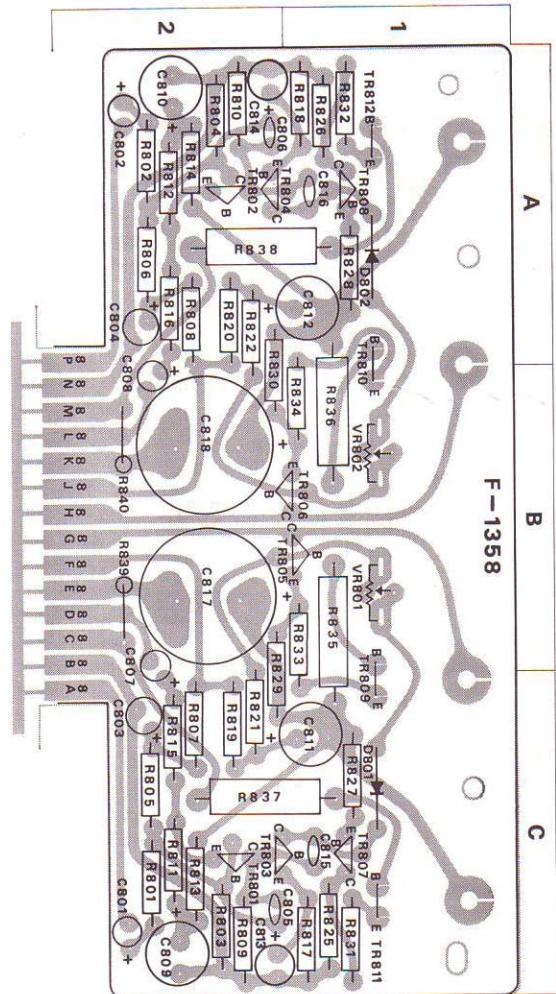

PRINTED CIRCUIT BOARDS AND PARTS LIST

W: Parts No. X: Parts Name Y: Stock No. Z: Position of Parts

EQUALIZER AND TONE BLOCK<F-1367> Stock No. 7560490

W	X	Y	Z	W	X	Y	Z	
R008	100Ω	0101101	2 B, C	R739	5.6kΩ	±10% ¼W CR.	0101562	2 B
R601	1kΩ	0101102	2 A	R740	5.6kΩ		0101562	2 C
R602	1kΩ	0101102	2 B	VR601	1kΩ (B)	1030820	2 B	
R605	470Ω	0101471	1 A	C010	100μF	25 V EC.	0513101	2 C
R606	470Ω	0101471	1 B	C601	1.5μF	10 V TC.	0571159	2 A
R607	2.2kΩ	0101222	2 A	C602	1.5μF		0571159	2 A
R608	2.2kΩ	0101222	2 B	C603	150pF	±10% 50 V CC.	0660151	2 A
R609	220kΩ	0101224	1 A	C604	150pF		0660151	2 A
R610	220kΩ	0101224	1 A	C605	47μF	6.3 V EC.	0510470	2 A
R611	270kΩ	0101274	2 A	C606	47μF		0510470	2 B
R612	270kΩ	0101274	2 B	C607	100pF	±10% 50 V CC.	0660101	2 A
R613	470Ω	0101471	1 A	C608	100pF		0660101	2 A, B
R614	470Ω	0101471	1 A	C609	10μF	25 V EC.	0513100	2 A
R615	6.8kΩ	0101682	1 A	C610	10μF		0513100	2 B
R616	6.8kΩ	0101682	1 A	C611	100μF	6.3 V EC.	0510101	1 A
R617	22kΩ	0101223	1 A	C612	100μF		0510101	1 B
R618	22kΩ	0101223	1 B	C613	1μF	50 V EC.	0515109	1 A
R619	220kΩ	0101224	1 A	C614	1μF		0515109	1 A
R620	220kΩ	0101224	1 B	C615	0.012μF	±10% 50 V MC.	0601127	1 A
R621	3.3kΩ	0101332	1 A	C616	0.012μF		0601127	1 B
R622	3.3kΩ	0101332	1 B	C617	0.003μF	±10% 50 V MC.	0601306	1 A
R623	39kΩ	0101393	1 A	C618	0.003μF		0601306	1 B
R624	39kΩ	0101393	1 B	C701	0.22μF	±10% 50 V CC.	0601228	1 B
R626	220Ω	0101221	2 B	C702	0.22μF		0601228	1 C
R701	39kΩ	0101393		C703	10pF	±10% 50 V CC.	0660100	1 B
R702	39kΩ	0101393		C704	10pF		0660100	1 C
R703	12kΩ	0101123	1 B	C707	10μF	25 V EC.	0513100	1 B
R704	12kΩ	0101123	1 C	C708	10μF		0513100	1 C
R705	82kΩ	0101823	1 B	C709	0.04μF	±10% 50 V MC.	0601407	1 B
R706	82kΩ	0101823	1 C	C710	0.04μF		0601407	1 C
R707	330kΩ	0101334	1 B	C711	0.001μF	±10% 50 V MC.	0601106	1 B
R708	330kΩ	0101334	1 C	C712	0.001μF		0601106	1 C
R709	1kΩ	0101102	1 B	C715	0.04μF	50 V EC.	0601407	1 B
R710	1kΩ	0101102	1 C	C716	0.04μF		0601407	1 C
R711	1kΩ	0101102	1 B	C717	1μF	50 V EC.	0515109	2 B
R712	1kΩ	0101102	1 C	C718	1μF		0515109	2 C
R713	3.3kΩ	0101332	1 B	C719	47μF	10 V EC.	0511470	2 B
R714	3.3kΩ	0101332	1 C	C720	47μF		0511470	2 C
R715	10kΩ	0101103	1 B	C721	10μF	25 V EC.	0513100	2 B
R716	10kΩ	0101103	1 C	C722	10μF		0513100	2 C
R719	2.7kΩ	0101272	1 B	C730	1μF	RN 50 V EC.	0519101	2 C
R720	2.7kΩ	0101272	1 C	C731	1μF		0519101	2 B
R721	22kΩ	0101223	1 B	TR601		0305475	2 A	
R722	22kΩ	0101223	1 C	TR602		0305475	2 A, B	
R723	5.6kΩ	0101562	1 B	TR603		0305475	2 A	
R724	5.6kΩ	0101562	1 C	TR604		0305475	2 A, B	
R725	10kΩ	0101103	1 B	TR701		0305475	1 B	
R726	10kΩ	0101103	1 C	TR702		0305475	1 C	
R731	2.2kΩ	0101222	2 B	TR703		0305475	2 B	
R732	2.2kΩ	0101222	2 C	TR704		0305475	2 C	
R733	100kΩ	0101104	2 C					
R734	100kΩ	0101104	2 B					
R735	270kΩ	0101274	2 B					
R736	270kΩ	0101274	2 C					
R737	3.3kΩ	0101332	2 B					
R738	3.3kΩ	0101332	2 C					

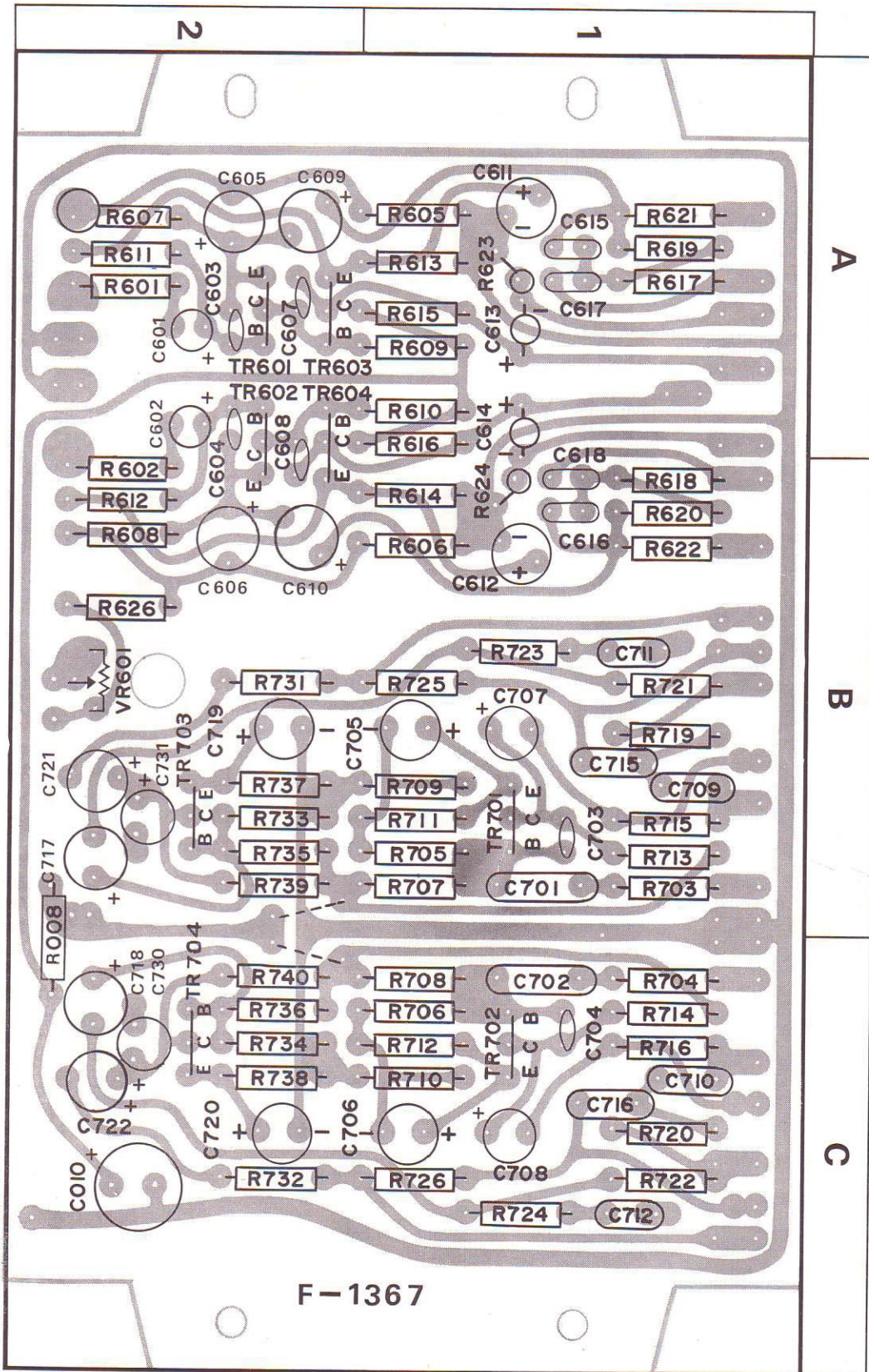

F-1367

PRINTED CIRCUIT BOARDS AND PARTS LIST

W: Parts No. X: Parts Name Y: Stock No. Z: Position of Parts

SYNTHESIZER BLOCK<F-1368-1> Stock No. 7650040

W	X	Y	Z
R001	180Ω ± 5% 1W CR.	0104181	1C
R002	100Ω	0111101	1B
R003	330Ω	0111331	1B
R004	18kΩ	0111183	1A
R901	33kΩ	0101333	2A
R902	33kΩ	0101333	2A
R903	47kΩ	0101473	2A
R904	47kΩ	0101473	2A
R905	390kΩ	0101394	2A
R906	390kΩ	0101394	2A
R907	180kΩ	0101184	2A
R908	180kΩ	0101184	2A
R909	8.2kΩ	0101822	1A
R910	8.2kΩ	0101822	1A
R911	10kΩ	0101103	1A
R912	10kΩ	0101103	1A
R915	3.9kΩ	0101392	2A
R916	3.9kΩ	0101392	2A
R921	2.2kΩ	0101222	1B
R922	2.2kΩ	0101222	1B
R923	5.6kΩ	0101562	2A, B
R924	5.6kΩ	0101562	2B
R925	2.2kΩ	0101222	2B
R926	2.2kΩ	0101222	2C
R927	220kΩ	0101224	2B
R928	220kΩ	0101224	2C
R929	1MΩ	0101105	1B
R930	1MΩ	0101105	1B
R931	4.7kΩ	0101472	1B
R932	4.7kΩ	0101472	1B
R933	1kΩ	0101102	2B
R934	1kΩ	0101102	2B
R935	39kΩ	0101393	2B
R936	39kΩ	0101393	2C
R937	2.2kΩ	0101222	2C
R938	2.2kΩ	0101222	2C
R939	220kΩ	0101224	2C
R940	220kΩ	0101224	2C
R941	1MΩ	0101105	1C
R942	1MΩ	0101105	1C
R943	4.7kΩ	0101472	1C
R944	4.7kΩ	0101472	1C
R945	1.2kΩ	0101122	2C
R946	1.2kΩ	0101122	2C
R947	39kΩ	0101393	2C
R948	39kΩ	0101393	2C
R949	18kΩ	0107183	1A
R950	18kΩ	0107183	1A
R951	82kΩ	0101823	2A
R952	82kΩ	0101823	2A
R953	2.2kΩ	0101222	1A
R954	2.2kΩ	0101222	1A
R955	47kΩ	0101473	1A
R956	47kΩ	0101473	1A
R957	1kΩ	0101102	1A
R958	1kΩ	0101102	1B

W	X	Y	Z
R959	100kΩ	0101104	1A
R960	100kΩ	0101104	1B
R959	47kΩ	0101473	2A
R960	47kΩ	0101473	2B
R963	2.2kΩ	0101222	2B
R964	2.2kΩ	0101222	2B
C001	1000μF	0549004	1B, C
C002	470μF	0514471	1B
C003	220μF	0515221	1C
C004	470μF	0513471	1B
C005	100μF	0513101	1A
C006	0.022μF	0650223	1A
C901	1μF	0515109	2A
C902	1μF	0515109	2A
C903	1μF	0515109	2A
C904	1μF	0515109	2A
C905	1μF	0515109	2A
C906	1μF	0515109	2A
C907	1μF	0515109	2A
C908	1μF	0515109	2B
C909	0.1μF	0601108	2A
C910	0.047μF	0601477	2B
C911	1μF	0515109	2A, B
C912	1μF	0515109	2B
C913	1μF	0515109	2B
C914	1μF	0515109	2C
C915	1μF	0519101	2B
C916	1μF	0519101	2B
C917	47pF	0660470	2B
C918	47pF	0660470	2C
C919	1μF	0515109	2C
C920	1μF	0515109	2C
C921	1μF	0519101	2C
C922	1μF	0519101	2C
C923	47pF	0660470	2C
C924	47pF	0660470	2C
C925	470pF	0660471	2A
C926	470pF	0660471	2A
TR001	2SC968 (YL) or 2SC1211 (D)	0305560 or 0805931	1A
TR901	2SC871R (F)	0305475	2B
TR902		0305475	2B, C
TR903		0305475	2C
TR904		0305475	2C
TR905		0305475	2A
TR906		0305475	2A
TR907		0305475	2A, B
TR908		0305475	2B
D001	SR1FM2	0310870	1C
D002		0310870	1C
D003	S1.5-02	0310960	1C
D004		0310960	1C
D006		0310960	
D007		0310960	

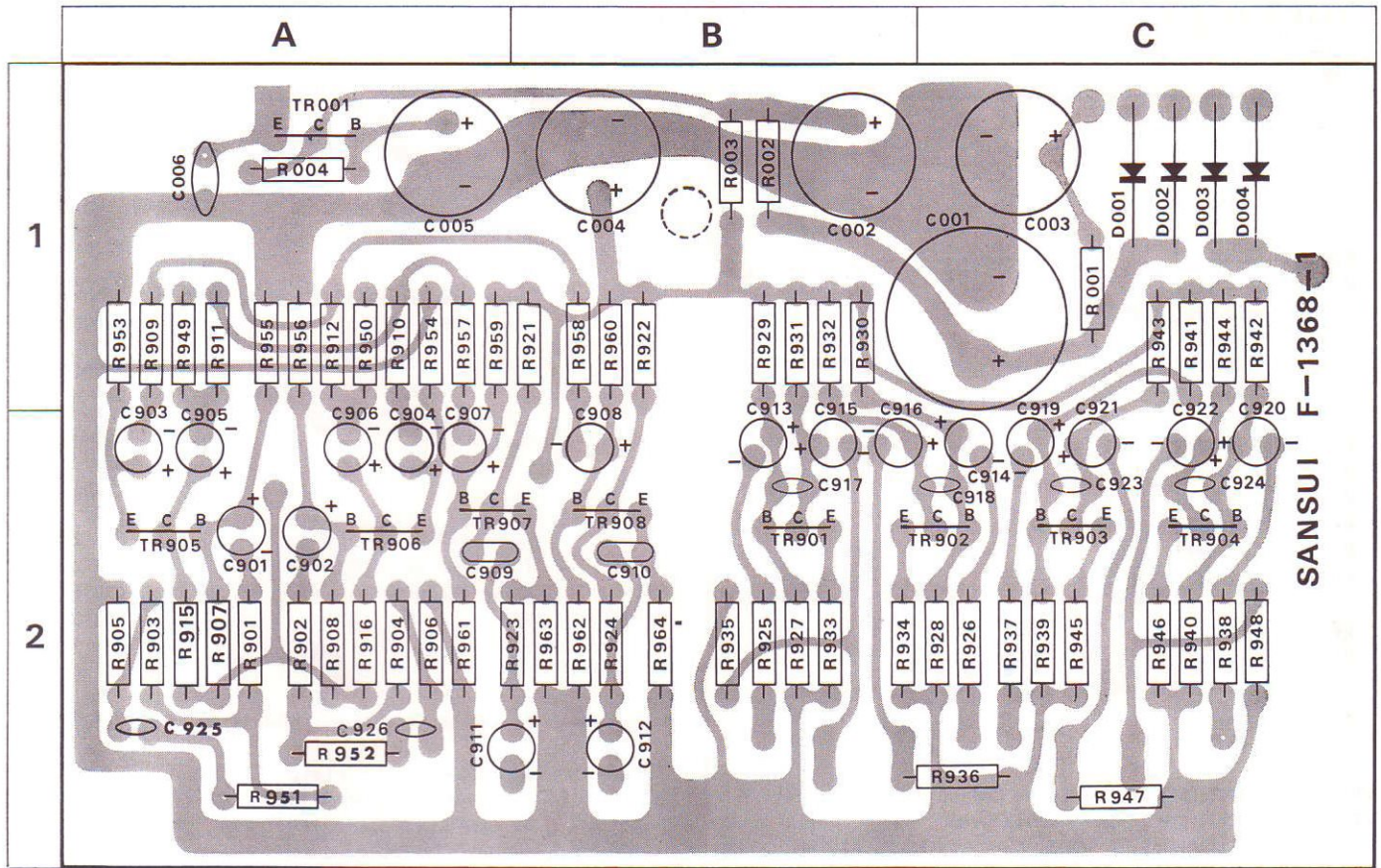

POWER BLOCK (F-1393) Stock No. 7500620

W	X	Y
R006	18k Ω	±10% ½W SR. 0111183
R008	22 Ω	
C007	1 μ F	50 V EC. 0515109
C008	470 μ F	10 V EC. 0511471
C009	100 μ F	50 V EC. 0515101
TR002	2SC968 (GR) or 2SC1211 (C, D)	0305561 or 0805930, 1
D005	SR1FM2	0310870

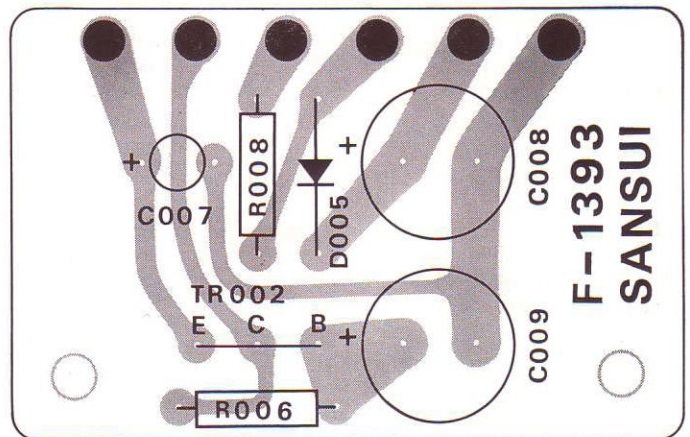

OTHER PARTS AND THEIR POSITION ON CHASSIS

W: Parts No. X: Parts Name Y: Stock No.

OTHER PARTS

W	X	Y
R010	33 Ω	0101330
R627	100k Ω	0101104
R628	100k Ω	0101104
R629	12k Ω	0101123
R630	12k Ω	0101123
R631	47k Ω	0101473
R632	47k Ω	0101473
R633	100k Ω	0101104
R634	100k Ω	0101104
R635	220k Ω	0101224
R636	220k Ω	0101224
R739	27k Ω	0101273
R740	27k Ω	0101273
R741	27k Ω	0101273
R742	27k Ω	0101273
R841	220 Ω	0111221
R842	220 Ω	0111221
R843	220 Ω	0111221
R844	220 Ω	0111221
R919	47k Ω	0101473
R971	47k Ω	0101473
R972	47k Ω	0101473
R973	8.2k Ω	0101822
R974	8.2k Ω	0101822
VR701, 702	250k Ω (B) \times 2	1040121
VR703, 704	250k Ω (B) \times 2	1040121
VR705, 706	100k Ω (B) \times 2	1010761
VR707, 708	100k Ω (B) \times 2	1010761
C011	2200 μ F 50 V EC.	0559306
C012	0.033 μ F \pm 20% 250V MPC.	0605337
C013	0.0047 μ F $\begin{matrix} +80\% \\ -20\% \end{matrix}$ 150V CC.	0659802
C014	220 μ F 16 V EC.	0512221
C015	0.022 μ F $\begin{matrix} +80\% \\ -20\% \end{matrix}$ 50 V CC.	0657223
C723	220pF	0641221
C724	220pF	0641221
C725	0.01 μ F	0601107
C726	0.01 μ F	0601107
C727	220pF	0641221
C728	220pF	0641221
C729	0.01 μ F	0601107
C730	0.01 μ F	0601107
C819	0.033 μ F	0651333
C820	0.033 μ F	0651333
C821	0.033 μ F $\begin{matrix} +100\% \\ -0\% \end{matrix}$ 75 V CC.	0651333
C822	0.033 μ F	0651333
D407	ZBI-12	0315061
S1 (a~m)	Selector Switch Y-5-14-5	1105120, 1
S2 (a, b)	Tape Monitor Switch	1130440
S4 (a, b)	Loudness Switch	
S3 (a~f)	Synthesizer/Decoder Switch	1130400
S5 (a~e)	Mode Switch Y-3-5-6	1103410
S6	Power Switch	1190020

W	X	Y
T001	Power Transformer	4001060
L302	AM Bar Antenna	4200280
L303	Micro Inductor	4900110
M001	200 μ A Tuning Meter	4300660
J801	Headphones Jack (Rear)	2430230
J802	Headphones Jack (Front)	2430230
DJ601	DIN Jack	2430040
PU001	Voltage Selector Plug	2410080
	Voltage Selector Socket	2410090
CO001	AC Outlet	2450040
F001	2A Power Fuse (100, 117V)	0431240
	1.5A Power Fuse (220, 240V)	0431230
	Power Fuse Holder	2300060
F002	3A	0431850
F003	1A	0431820
F004	1A	0431820
	Wired in Fuse	
F801~804	1.5A Quick Acting Fuse	0433222
PL001~004	6.3V 250mA Dial Scale Lamp	0420020
PL005	6.3V 250mA Tuning Meter Lamp	0420020
PL006	5V 60mA Dial Pointer Lamp	0400101
PL007	6V 100mA FM Stereo Indicator	0400161
PL008	7V 200mA 2-Channel Indicator	0400152
PL009	7V 200mA 4-Channel Indicator	0400151
PL010	7V 200mA Synthesizer Indicator	0400150

* Design and specifications subject to change without notice for improvements.

